

# feather&black

## Frensham Bed - Assembly Instructions

Product size: 1260mm H x 2015 mm W x 1455mm D (double)  
1260mm H x 2115 mm W x 1605mm D (king)  
1260mm H x 2115 mm W x 1915mm D (super king)

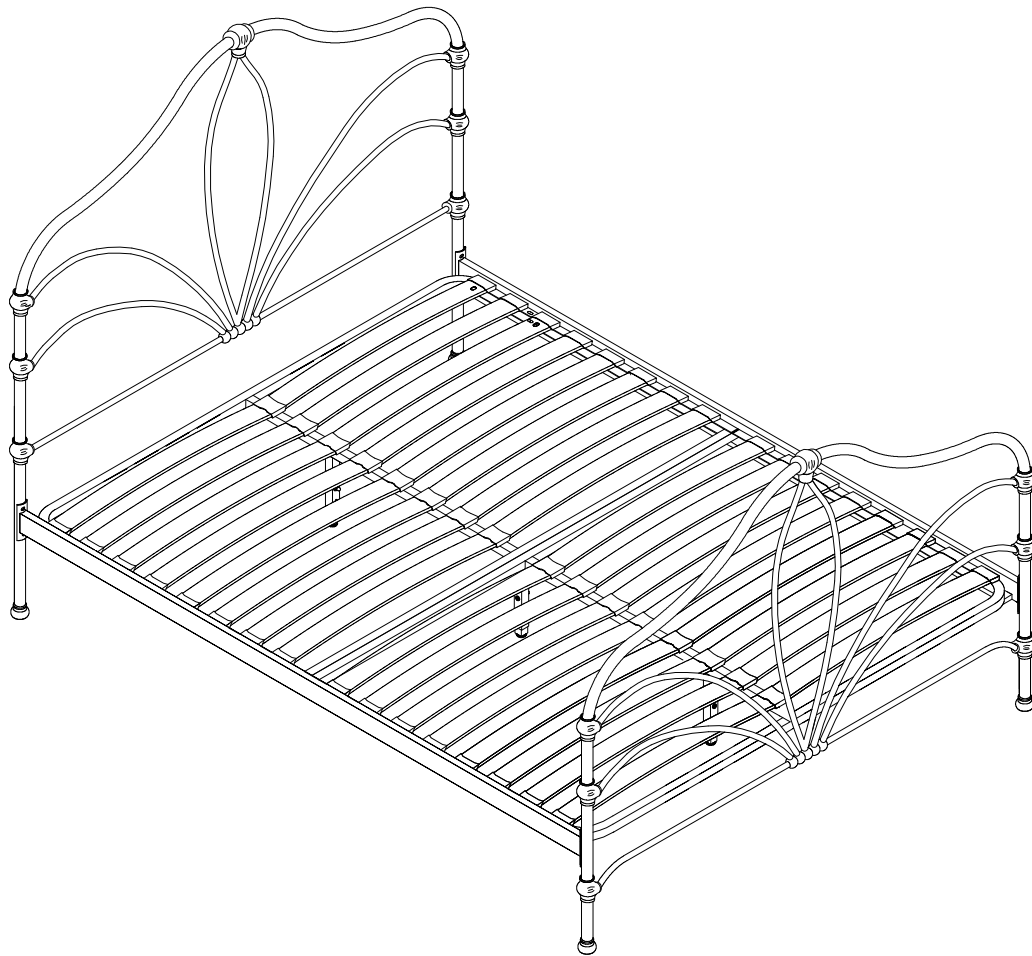

If you require any advice during assembly, please call our customer service team on 01243 380600

**Please retain these assembly instructions for future use**

## Frensham Bed

### Before you start

Thank you for purchasing this frensham bed.

Please read these instructions fully prior to assembly to familiarise yourself with the various stages of construction. Carefully open all packs supplied and check the contents against the parts and fittings check list.

Do not destroy any of the packaging until you are certain that you have all the necessary parts for the assembly.

This item is heavy once assembled. Please try to assemble the item as close as possible to the point of use. Take care when moving the item to avoid personal injury or damage to the product and always lift rather than drag.

There are small components used in the construction of this furniture as well as plastic packaging, these should be kept away from young children whilst assembling.

#### Product Safety

All assembly fastenings should always be tightened properly, and care should be taken to ensure that no fittings are loose.

Periodically check and ensure that all components are in their proper position, free from damage, and that all connectors are tight.

Please note depending on the lighting, positioning and surroundings of your room, the shade of the colour can sometimes appear slightly different. Over a period of time the colour might lighten or fade slightly due to light exposure.

#### Product Care

To clean, slightly moisten cloth with water and wipe surfaces. A damp cloth holds dust and prevents damage. repeat with a dry, soft, lint-free cloth. Do not use abrasives or cleaning products which may contain ammonia or solvents.

#### Number of people required to assemble

Two person to assemble the product and two people to lift in to position.



#### Time to assemble



30 min

#### Necessary tools



#### Missing parts or faulty products

If you are missing any fixtures or fittings during assembly, or a part is unfortunately faulty please call our customer service team on 01243 380600

# feather&black

## Frensham Bed

### Components supplied (not actual size)

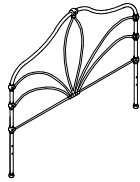

A:Headboard  
1455x60x1260mm(double)  
1605x60x1260mm(king)  
1915x60x1260mm(super king)  
1 pcs

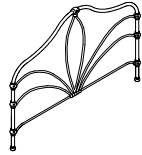

B:Footboard  
1455x60x1060mm(double)  
1605x60x1060mm(king)  
1915x60x1060mm(super king)  
1 pcs

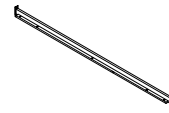

C:Side rails  
25x60x1920mm(double)  
25x60x2020mm(king)  
25x60x2020mm(super king)  
2 pcs

### Fixtures and fittings supplied (not actual size)

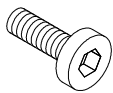

H1:bolt  
m6x20mm  
8 pcs

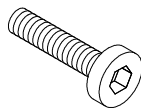

H2:bolt  
m6x35mm  
4 pcs

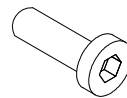

H3: nut  
m6x30mm  
4 pcs



H4: metal washer  
Ø16xØ6x1mm  
12 pcs



H5:plastic washer  
Ø24xØ8x2mm  
8 pcs

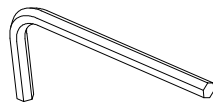

H6: allen key  
4mm  
2 pcs



0 cm  
1  
2  
3  
4  
5  
6  
7  
8  
9  
10  
11  
12  
13  
14  
15  
16  
17  
18

# feather&black

## Frensham Bed

1.

(1) Use bolt (H1), washer (H4) and plastic washer (H5) to fix the side rail (C) on to headboard (A) and footboard (B) by using allen key (H6).

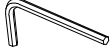
-  H1.m6x20mmx8pcs
-  H4.metal washerx8pcs
-  H5.Plastic washerx8pcs
-  H6.4mm allen keyx2pcs

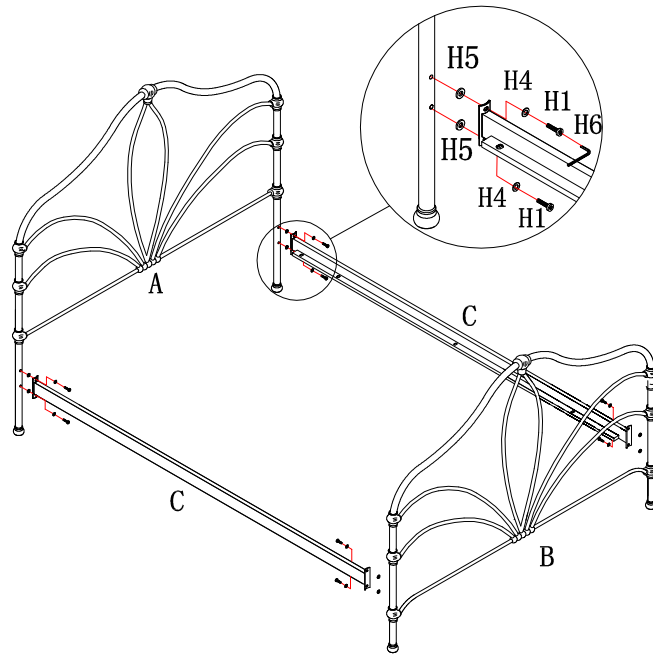

# feather&black

## Frensham Bed



2.

(1) Use the bolt ( found inside the slat frame box ) to fix support leg on to the slat frame.

(2) Carefully locate the slats on to the unit.

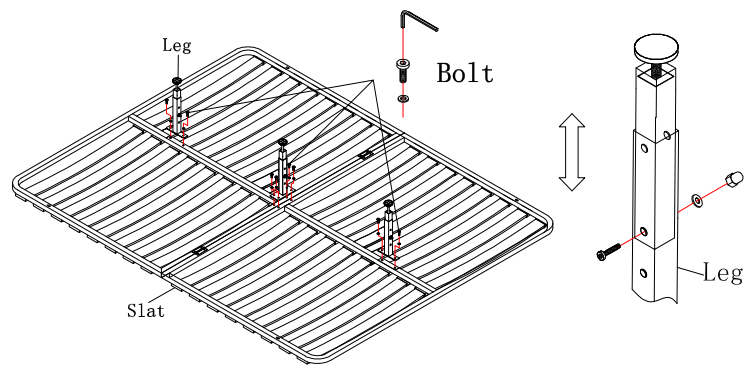
(3) Use bolt (H2) and nut (H3) to fix the unit using the allen key (H6).

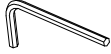

-  H2.m6x35mmx4pcs
-  H3.m6x30mmx4pcs
-  H4.metal washerx4pcs
-  H6.4mm allen keyx2pcs

